

# Concept Pro

5MP

30M  
IR

2.8-8mm  
MOTORISED  
LENS

IP



## AIR3525AEEL-IP5M-Z

### Concept Pro 5MP IP Motorised Bullet Camera

The AIR3525AEEL-IP5M-Z model is an IP camera that has been designed to deliver the highest image quality for demanding external environments. This weather-resistant external small bullet features a 2.8-8mm motorised lens, smart infrared LEDs with 30m illumination range, and provides crisp 5-megapixel video. This camera is also designed for excellent compatibility with the Concept Pro range of network video recorders.

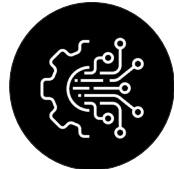

**AI Motion Detection**  
Reduce false motion detection alarms by up to 95% using new AI Motion Detection technology. Trained with AI algorithms, the camera can recognise and trigger motion detection events only if a person is detected in the specified area. As a result, false alarms from sources such as lights, animals, foliage, weather, and other objects are effectively filtered and reduced.

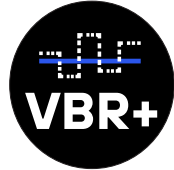

**Intelligent, Efficient Bit Rate Control**  
Reduce camera streaming bit rates by up to 90% by using Variable Bit Rate (VBR) or VBR+ smart bit rate control settings. These dynamic features maximise overall image quality while minimising camera stream bit rates. This results in lower network bandwidth usage and extended recording storage retention time.



**Enhanced Low Light Performance**  
This model utilises an Enhanced Low Light Image Sensor with greater light sensitivity, resulting in the camera capturing colour images long after standard CCTV cameras have switched to black & white night mode and brighter images in darker conditions.

### KEY FEATURES

- ♦ Max. 25FPS @ 5MP
- ♦ 2.8-8mm Motorised Lens
- ♦ Up to 30m Smart IR Illumination
- ♦ AI Motion Detection
- ♦ H.265 Video Codec & VBR+ Smart Bit Rate Control
- ♦ Enhanced Low Light Performance

### OTHER FEATURES

- ♦ PoE/DC12V Power Input
- ♦ True WDR, ATW, BLC, Defog, 3D-DNR
- ♦ Manual Regions of Interest
- ♦ IP67 Rated
- ♦ ONVIF Profile S Compliant

VISIT THE  
**Concept Pro**  
  
 WEBSITE

# AIR3525AEEL-IP5M-Z

## Concept Pro 5MP IP Motorised Bullet Camera



### SPECIFICATION

Model/Feature	AIR3525AEEL-IP5M-Z
Video Output Type	IP
Image Sensor	1/2.8" Progressive Scan CMOS
Signal System	PAL/NTSC
Min. Illumination	Enhanced Low Light Performance - Colour: 0.004 Lux @ (F2.0, AGC ON) B&W: 0 lux with IR LEDs on
Electronic Shutter	Auto/Manual, 1/25 to 1/5,000s
S/N Ratio	≥48dB
IR LEDs	x4
IR Illumination Range	Max. 30m
IR Control	Auto/Off
Adaptable IR	Auto
Pan/Tilt/Rotation Range	P: 0°-360°, T: 0°-90°, R: 0°-360°
Lens Type	Motorised Lens
Mount Type	Built-in
Focal Length	f=2.8-8mm
Aperture	F1.6
Angle of View	H: 102.8-50.0°, V: 74.1-37.4°, D: 142.5-62.5°
Focus	Auto/Manual
Iris	Fixed Iris
Compression	H.265/H.264 with VBR+ Smart Codec Option
Streaming Capability	Triple Streaming + SVC Stream
Resolution	2592x1944, 2592x1520, 2304x1296, 2048x1536, 1920x1080, 1280x1024, 1024x768, 1280x720, 704x576, 704x480, 640x480, 640x360, 352x288, 352x240
Frame Rate	Stream 1: Max. 25FPS @ 2592x1944, Stream 2: Max. 25FPS @ 1280x720, Stream 3: Max. 25FPS @ 640x480
Bit Rate Control	CBR/VBR/VBR+
Bit Rate	Stream 1: 1,000-8,000kbps, Stream 2: 600-2,000kbps, Stream 3: 600-2,000kbps
Day/Night	True D&N with ICR (Auto/Day/Night/Schedule)
Backlight Compensation	Yes
Wide Dynamic Range	True WDR
White Balance	ATW/Manual (Indoor/Fluorescent/Outdoor)
Gain Control	Auto
Noise Reduction	3D-DNR (Auto/Manual)
Motion Detection	Yes (Max. 4 Areas)
Defog	Yes
Image Setting	Mirror, Flip, Corridor Mode
Image Adjustment	Brightness, Sharpness, Colour Gain
Region of Interest	Manual (Max. 8 Regions)
Defog	Yes
Slow Shutter	Off/x2/x4/x8
Image Setting	Mirror, Flip, Corridor Mode
Image Adjustment	Brightness, Contrast, Colour, Sharpness
Privacy Masking	Yes (Max 4 Areas)
Tamper Detection	Yes
AI Motion Detection	Yes (Human Detection)
AI Video Analytics	-
Transmission Distance	Max. 100m over Ethernet
Ethernet	x1 RJ45 10M/100M Ethernet
Protocol	IPv4, IPv6, IGMP, ICMP, ARP, TCP, UDP, DHCP, RTP, RTSP, RTCP, DNS, DDNS, NTP, SMTP, FTP, UPnP, HTTP, HTTPS, SSL/TLS, 802.1x
Security	Complex password requirement, user authentication, digest authentication, TLS 12, HTTPS, RTSP over TLS
Interoperability	ONVIF Profile S, HTTP/RTSP API
ONVIF Channels	Max. 4 Streams
Streaming Method	Unicast/Multicast
Max. User Access	x10
Edge Storage	Local PC (Snapshot/Recording)
Video Output	-
Alarm Interface	-
Audio Interface	-
Audio Compression	N/A
RS-485	-
Control Protocol	N/A
Reset Buttons	Yes
Power Supply	PoE/DC12V
Power Consumption	PoE: Max. 7.77W with IR on
Power Output	-
Operating Temperature	-20°C to +50°C
Operating Humidity	0% to 90%
Ingress Protection	IP67
Impact Resistance	-
Housing Materials	Aluminium Die-Casting
RAL	RAL7021 Black Grey
Dimensions	(Ø) 66mm x (L) 209mm without sunshield
Net Weight	≈550g
Gross Weight	≈700g
Certification	CE

### ORDER CODE

**AIR3525AEEL-IP5M-Z** Concept Pro 5MP IP Motorised Bullet Camera

### OTHER PRODUCTS IN THE RANGE

**AIR3525AEEL-IP5M/2.8** Concept Pro 5MP IP Fixed Bullet Camera (2.8mm)  
**AIR3525DLEL-IP8M/2.8** Concept Pro 8MP IP Deep Learning Fixed External Small Bullet Camera  
**AIR3525AEEL-IP5M/4** Concept Pro 5MP IP Fixed Bullet Camera (4mm)

### RECOMMENDED ACCESSORIES

**CP-BASE-1-V2-G** Concept Pro Small Junction Box - Black Grey  
**CP-PM-1-V2-G** Concept Pro Small Pendant Mount  
**CP-VM-1-V2-G** Concept Pro Small Wall Mount  
**CP-PLM-V2** Concept Pro Pole Mount  
**CP-CM-V2** Concept Pro Corner Mount

### DIMENSIONS

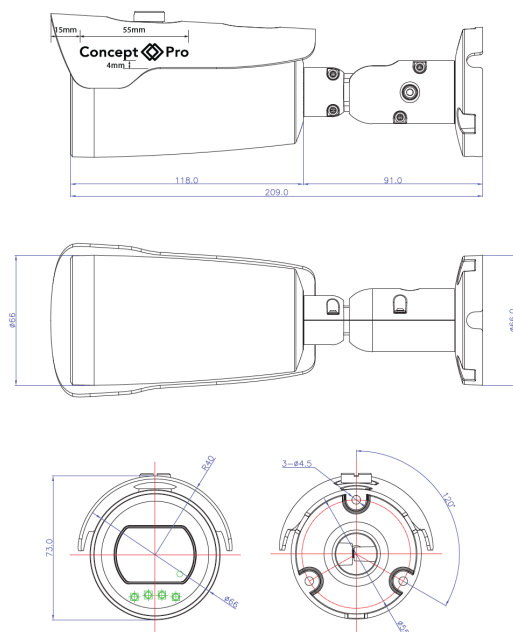

VISIT THE  
**Concept Pro**



WEBSITE

# AIR3525AEEL-IP5M-Z

Concept Pro 5MP IP Motorised Bullet Camera

# Concept Pro

## ACCESSORIES

## DIMENSIONS

### CP-BASE-1-V2-G

Concept Pro Small Junction Box

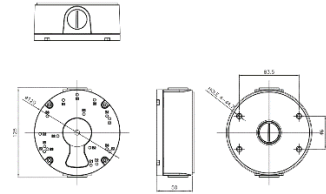

### CP-PM-1-V2-G

Concept Pro Small Pendant Mount

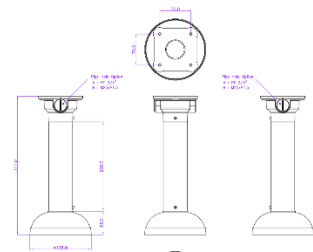

### CP-WM-1-V2-G

Concept Pro Small Wall Mount

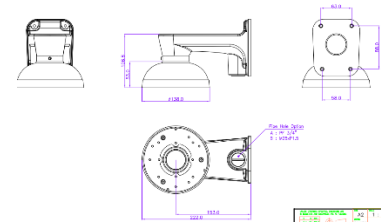
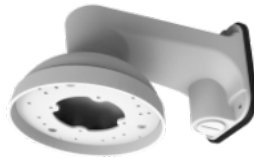

### CP-PLM-V2

Concept Pro Pole Mount (can be combined with CP-BASE-1-V2)

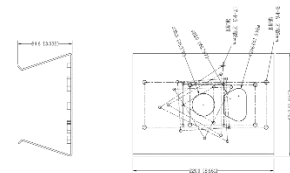

### CP-CM-V2

Concept Pro Corner Mount (can be combined with CP-BASE-1-V2)

